

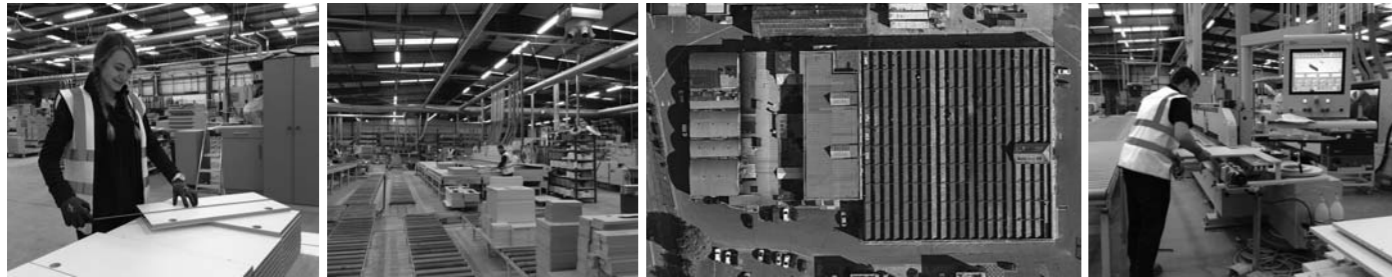

TRADE APPROVED QUALITY KITCHENS

EVOKITCHEN
COLLECTION



- Cabinets built in the UK
- European engineered hinges
- Italian styled gloss doors
- 5 year guarantee on furniture
- Trade services available

EVOBUILTTOLAST

The team behind Evo really understand kitchens. We appreciate your kitchen not only needs to look great, but to pass the trade test they need to be great quality and easy to install too. Evo Kitchens are loved by installers and customers alike.



I am a kitchen fitter, and I have now fitted a number of your kitchens and love your product. I've been in the trade for over 35 years and have therefore fitted most of your competitors products, and yours are the best

R Eaton



Evo Dove Grey Gloss - 4



Evo Gloss Cream - 6



Evo Gloss White - 8



Evo Matt Dove Grey - 10



Evo Drift Wood - 11



Evo Cream Shaker - 12



Evo Oak Shaker - 13

CONTENTS

Solutions, worktops & panels	14
Appliances, sinks, taps & lighting	15
Handles	16
Accessories	17
Cabinets	18
Hinge options	18
Drawer options	18
Range content	19



EVOKITCHENS

Evo kitchens do not compromise on quality and value. Using the very best in manufacturing techniques we are able to create a beautiful mix of colour, size and finish.

We offer choices of drawer boxes, hinges and handles too, this way you can tailor your Evo Kitchen to your taste and budget.

EVODOVEGREYGLOSS

In a beautiful lacquered finish, Evo Dove Grey Gloss represents the best of European design and quality. Using our concrete effect Solutions shelving and worktops adds interest and texture to your kitchen.

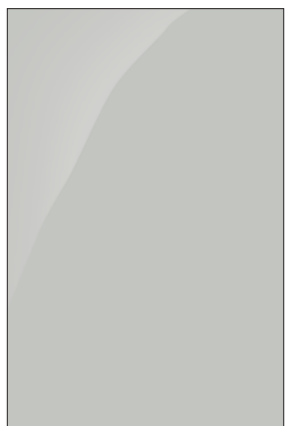



EVOGLOSSCREAM

A classical warm tone, the lacquered finish of Evo Gloss Cream is a popular choice. Again blended with Evo Solutions shelving and worktops, the finish is rich and contemporary.



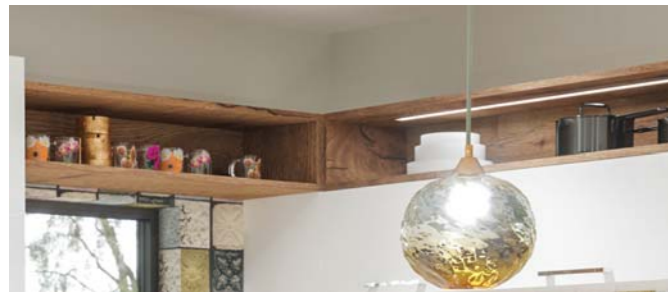

Solutions panels allow installers to fabricate accent shelving - see page 14 for details

EVOWHITEGLOSS

Evo White Gloss is a long standing winner. The third lacquered door in the Evo Collection, it creates a fresh feel, easily mixed with other colours and finishes to find your own bespoke look. Again shown with Solutions worktops and shelving for a European and bespoke appearance.





EVOMATTDOVEGREY

European styling in an on-trend matt grey that will create a stunning, modern kitchen. This practical, flat door offers a designer look that's also easy to keep clean.

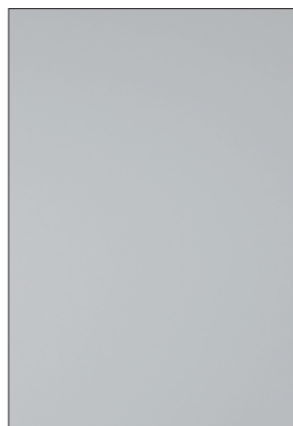

EVODRIFTWOOD

An attractive horizontal woodgrain effect slab door that looks equally stylish as a full kitchen, or paired with our Evo gloss kitchens as an accent colour.





EVOCREAMSHAKER

A timeless shaker door in a soft, cream colour – choose from our wide range of handles to dress as traditional or more modern in style.



EVOOAKSHAKER

This five piece oak effect shaker door offers a great value alternative to a solid timber kitchen. Create a modern or traditional look by choosing from our extensive selection of handles and worktops.



EVO SOLUTIONS WORKTOPS & PANELS

Whatever your chosen Evo Kitchen style, you won't ever be stuck for choice with our premium square edged range of laminate worktops. Our authentic woodgrain effect Solutions worktops are available in four natural colours and include upstands and panels to create open shelving and splashbacks.



Natural worktop



Concrete worktop



Open shelving



Natural Oak



Tobacco Oak



White Oak

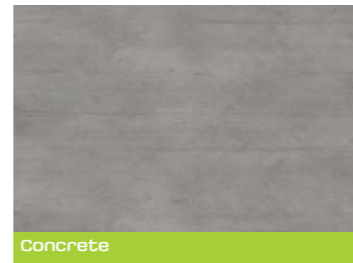

Concrete

Worktops: 4100 x 600 x 38mm, 3000 x 900 x 38mm Breakfast Bar, 900 x 900 x 38mm double sided Breakfast Bar End (Note: Concrete 28mm) • Upstands: 3000 x 100 x 18mm • Panels: 2400 x 900 x 18mm, 900 x 600 x 18mm

Artis worktops, splashbacks and upstands are available in over 50 stunning shades.

ARTIS Special effects - 3.6m & 1.8m surfaces



BURNISH - 12 Choices



SNOW - 16 Choices



GLOSS - 3 Choices

ARTIS Textures - 4.1m & 3.0m surfaces



GRANITE - 9 Choices



SILKWOOD - 18 Choices



CRYSTAL - 6 Choices

EVO APPLIANCES, SINKS, TAPS & LIGHTING

Best brands @ the best prices...

Our collection of built-in appliances, sinks and taps are designed to complement our kitchens. Choose from Matrix, CDA or Belling appliances and Carron Phoenix sinks and taps.



COOKING

Our range of ovens, hobs and extractors from CDA, Matrix and Belling has everything you need to cook up a storm in your new Evo Kitchen



COOLING

Choose from under counter or tall fridge freezers from our selection of built-in refrigeration. Wine coolers in several sizes are also available to create a smart focal point in the kitchen



DISHWASHING

We have a number of size options and specifications available, from slimline to full width models, all A rated for energy consumption



LAUNDRY

Washing and drying with a multitude of programmes is important in today's busy kitchen with fully concealed laundry products available from CDA and Belling



SINKS - Granite | Stainless Steel | Ceramic

From traditional charm to cutting edge minimalism, our collection encompasses the very best modern design and materials to help you create a kitchen bursting with beautiful features



TAPS

Our tap collection includes ultra-modern pullout spray taps, hot water taps, traditional swan neck or single lever. A choice of finishes including chrome, brushed steel, copper and even black to really make a statement

Our range of LED lighting has everything you need to create task or ambience lighting in your kitchen.

Cabinet Lighting



Nova Mini LED Ultra-Thin Cabinet Light



Galaxy COB LED Stainless Steel Tri-Light



Nano Panel Light

Plinth Lighting



Sola IP65 LED Plinth Light Frosted Lens



Strata LED Plinth Light

Drawer Lighting



Sabre LED Drawer Light with IR Sensors

Our collection of over 60 handle styles has something to suit every kitchen design. Our Evo doors and drawer fronts are not pre-drilled for handles, allowing you to choose your favourite design.



Group A



Group B



Group C



Group D

Group A

1. Handle H941
2. Handle H947
3. Handle H1004
4. Handle H1008
5. Handle H1003
6. Handle H1007
7. Handle H146
8. Handle H931
9. Handle H919
10. Handle H918
11. Handle H933
12. Handle H018
13. Handle H022
14. Handle H932
15. Handle H003

Group B

16. Handle H222
17. Handle H318
18. Handle H916
19. Handle H951
20. Handle H950
21. Handle H1013
22. Handle H1015
23. Handle H1011
24. Handle H820
25. Handle H917
26. Handle H264
27. Handle H5615
28. Handle H5616
29. Handle H5617

Group C

30. Handle H486
31. Handle H944
32. Handle H943
33. Handle H945
34. Handle H150
35. Handle H948
36. Handle H1009
37. Handle H149
38. Handle H1010
39. Handle H1002
40. Handle H1006
41. Handle H1005
42. Handle H942
43. Handle H920
44. Handle H504
45. Handle H956
46. Handle H962
47. Handle H363
48. Handle H949
49. Handle H004

Group D

50. Handle H1029
51. Handle H1023
52. Handle H1017
53. Handle H1018
54. Handle H1019
55. Handle H1020
56. Handle H1028
57. Handle H1026
58. Handle H1027
59. Handle H1025
60. Handle H1024
61. Handle H1030
62. Handle H1022
63. Handle H1031

We have a range of accessories to complement our Evo Kitchens, including Kesseböhmer wirework. The name Kesseböhmer stands for innovative solutions and a powerful blend of design, function and quality.

larder storage



300mm Soft Close Larder Pull Out with Baskets



600mm Soft Close Tandem Larder with Baskets



500 / 600mm Tandem Solo Larder with Baskets

base unit storage



Soft Close 150 or 300mm Pull Out Base with Baskets



1/3 Carousel for 950L Corner Base Unit.



Universal Corner optimiser (not Kesseböhmer)



Magic Corner for 1000mm Corner Base Unit. LH/RH (LH Shown). Soft close



Le Mans for 1000mm Corner Base Unit LH/RH (LH Shown)



Linea 130 bin

423 x 253 x 467mm - 30 litres
Suits 300mm base



Linea 230 bin

423 x 253 x 467mm - 2 x 15 litres
Suits 300mm base



Linea 330 bin

423 x 253 x 467mm - 3 x 10 litres
Suits 300mm base



Waste bin - 12L

Suits 400mm base



Excel pan drawer dividers



Plastic cutlery tray



Telescopic towel rail



Soft close pull out baskets

Installers love our cabinets and we believe they're the best out there!



All panels are fully PVC edged to protect against moisture penetration



Adjustable service void offers flexibility when accommodating pipework 45-70mm



Concealed wall hanging bracket creates a clean look and offers a 15mm wiring void



Removable back panel in base units - a simple yet easy way to aid installation and service access



Robust adjustable legs protect against moisture ingress and is an easy way of making the cabinet level



All 18mm thick high density panels in base cabinet means no weak points - they're extra sturdy!



Minimum holes in side panels for a clean, high end appearance



330mm deep wall cabinets as standard give ample storage and will fit a 12 inch dinner plate

EVOHINGEOPTIONS

Our hinges are manufactured in Salice's state-of-the-art factory in Italy to the highest quality standards. Cabinets come with non-soft close hinges as standard, with a soft close option available as an upgrade.



Standard



Soft Close

SALICE

EVO DRAWER OPTIONS

Your Evo Kitchen will come with non-soft close Metabox drawer boxes as standard. You can upgrade to a soft close attachment on the Metabox, or upgrade the whole drawer to our Excel.



Metabox

- Non soft close
- Single walled metal sides (silver)
- 25kg load bearing capacity
- Soft close attachment upgrade available



Excel

- Available upgrade
- Soft close
- Twin walled
- 40kg load bearing capacity

EVO RANGE CONTENT

EVOBASEUNITS

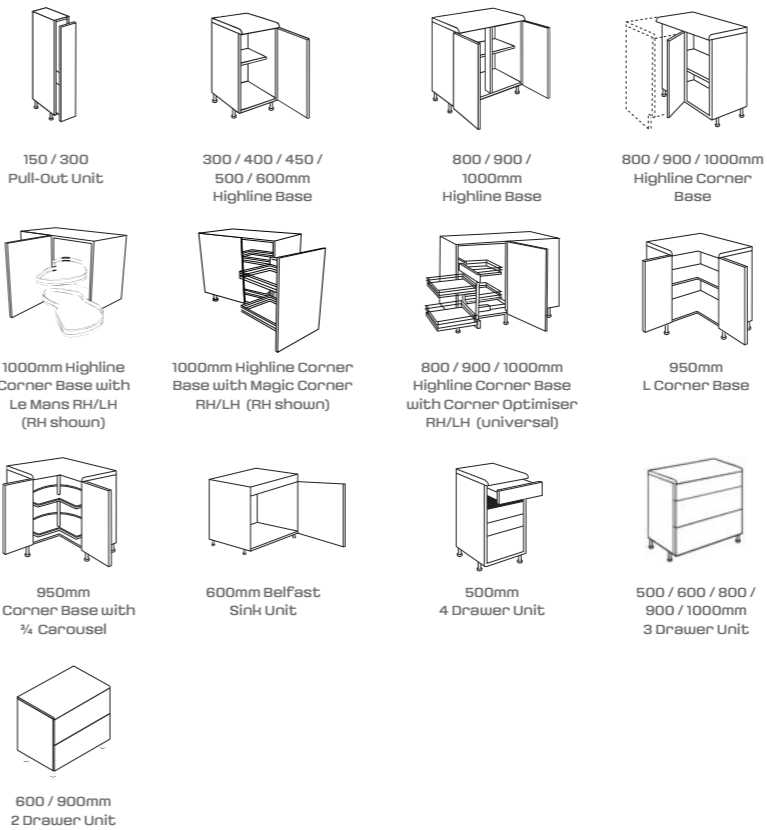

EVO WALL UNITS

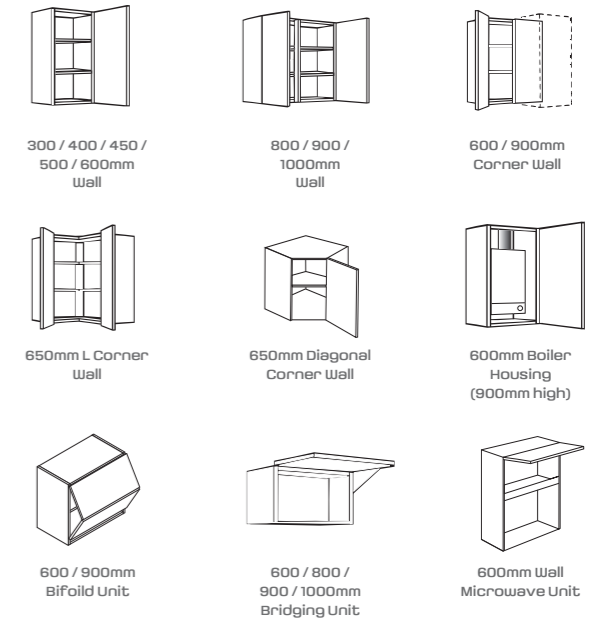

Wall replacement ends are available for our 720 x 330mm wall units.

EVO LARDER UNITS

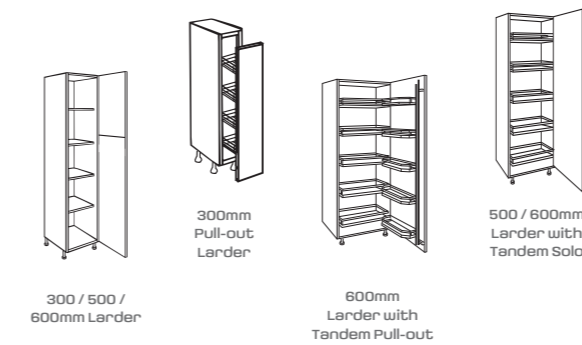

EVO APPLIANCE HOUSINGS

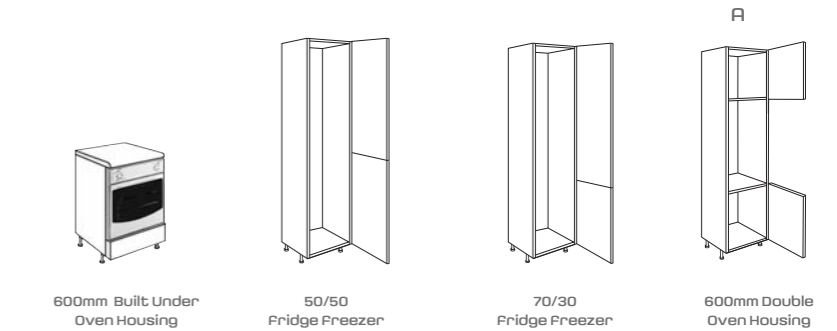

EVO APPLIANCE HOUSINGS

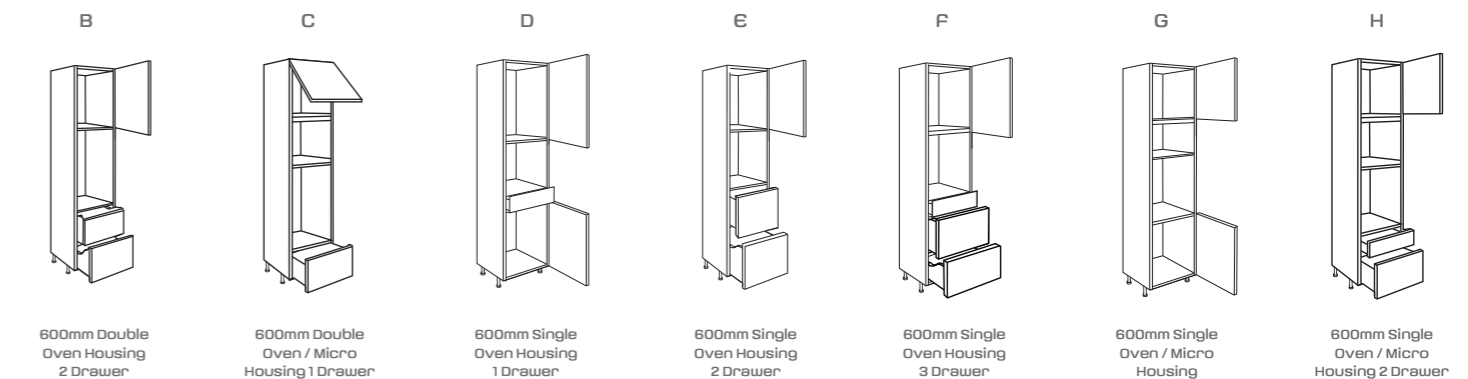

Note: tall unit end panels are 2140mm and extend to the floor

EVOTECHNICAL SPECIFICATIONS

End Elevations - check appliance/larder height prior to setting wall unit height

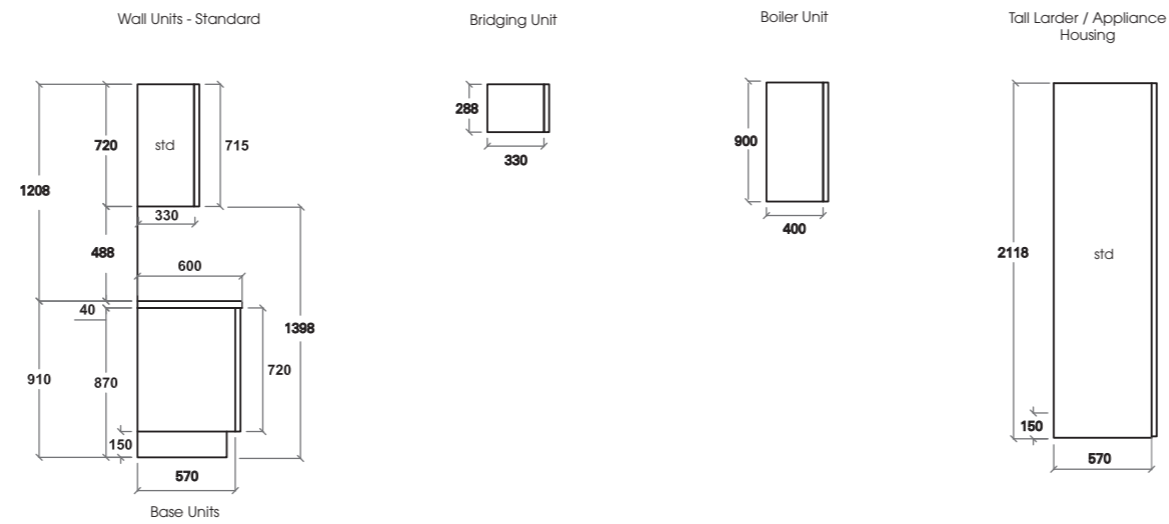

Standard appliance housing / Larder / Fridge Freezer (FF) configurations

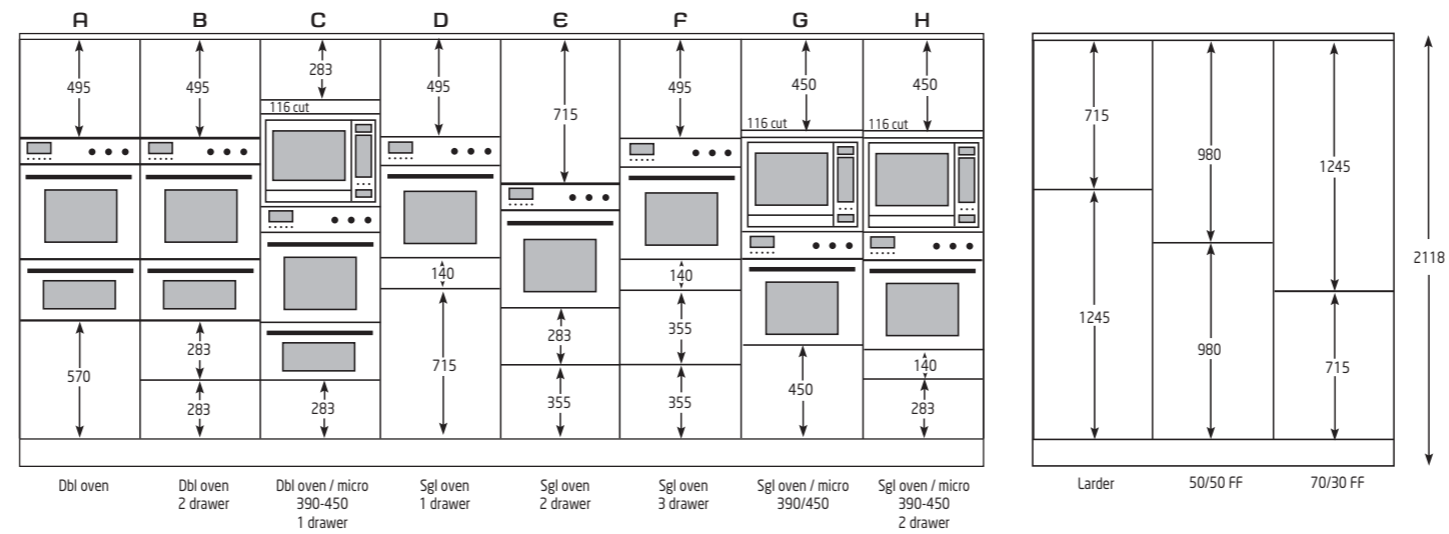

Corner Information

800mm Conventional Corner Base Unit

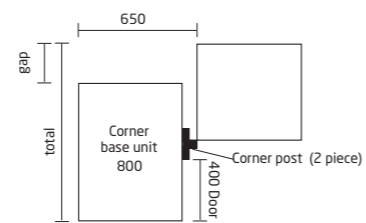

If using alternative door sizes the gap to the wall changes and centre post of cabinet would require refixing.
 300mm door = 150mm gap (950mm total)
 400mm door = 250mm gap (1050mm total)
 450mm door = 300mm gap (1100mm total)

900mm Conventional Corner Base Unit

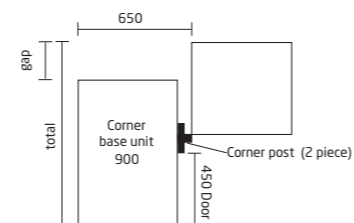

If using alternative door sizes the gap to the wall changes and centre post of cabinet would require refixing.
 450mm door = 200mm gap (1100mm total)

1000mm Conventional Corner Base Unit

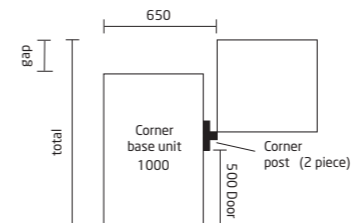

If using alternative door sizes the gap to the wall changes and centre post of cabinet would require refixing.
 500mm door = 150mm gap (1150mm total)
 600mm door = 250mm gap (1250mm total)

650 Diagonal Wall Unit

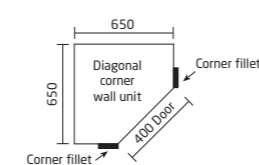

Cabinet Dimensions 632mm.
 (Requires colour matched infill panels)

600/900mm Conventional Corner Wall Unit

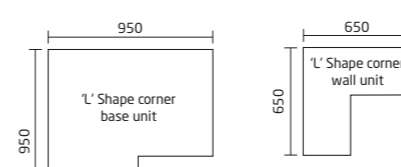
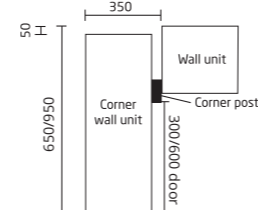

L' Shape Corner Units
 Note:- Walls must be square to accommodate L shaped units.